

# KETRA

## S38 TRACK LUMINAIRE

Project: \_\_\_\_\_  
 Comments: \_\_\_\_\_  
 Prepared By: \_\_\_\_\_



Leverage the full feature set of Ketra's S38 or S30 LED Lamp

Constant torque hinge provides 90° of tilt aiming at any increment, without the need for a mechanical lock

365° of rotation eliminates any aiming shadows

Configurable with industry standard track systems and conduit mount option

### HARDWARE ORDERING GUIDE

TA	S38					1	GU24		
Series	Form Factor	Lumens	Platform	Control	Beam Angle	Region	Base Type	Adapter Type	Housing Color
		code			code			code	code
Series	Track Luminaire	TA	Control	Track Adapter Only	-	Adapter Type	"H-Type" Compatible	H	
				Tunable	T		"J-Type" Compatible	J	
							"L-Type" Compatible	L	
Form Factor	S38	S38	Beam Angle	Track Adapter Only	-		1/2" NPT Canopy Mount	N	
				Spot (15°)	SP	Please see the track adapter compatibility guide prior to placing order			
				Flood (25°)	FL	Housing Color			
Lumens	S30-800lm	08		Wide Flood (40°)	WFL		White	WH	
	S30-1000lm	10		Very Wide Flood (60°)	VFL		Black	BK	
	S38-900lm	09					Accessory Order Codes		
	S38-1100lm	11					See Page 2 for Accessory options		
Platform (see page 3 color chart)	Track Adapter only	-	Region	NA 120 V 60 Hz	1				
	Wide Gamut	B	Base Type	GU24	G24				

770-000016-01 r07

Specifications are subject to change without notice

# KETRA

## S38 TRACK LUMINAIRE

### SPECIFICATIONS<sup>1</sup>

#### OPTICAL PERFORMANCE

Lumen Output <sup>2</sup>	900 lm/ 1100 lm
CRI (Ra) <sup>3</sup>	>90 (R9>90)
Lumen Maintenance <sup>4</sup>	36,000 hours to L70 @ 25°C T <sub>A</sub>
Color Spatial Uniformity	<2 MacAdam ellipses across field angle
Color Point Maintenance	<1 MacAdam ellipse over product lifetime
Equivalent Traditional Lamp	75W/ 100W halogen PAR38
Dimming Range <sup>5</sup>	0.1-100% lm

#### ENVIRONMENTAL

Operating Temperature (T <sub>A</sub> ) <sup>6</sup>	0-50°C
Storage Temperature	-20-80°C
Humidity	0-95%, Non-condensing
Certification	UL, cUL, RoHS, FCC Class B
Location	UL Damp Location, IP20, Suitable for use in fully enclosed luminaires

#### MECHANICAL

Weight	13.8 oz, 390 g
Housing Material	Powder Coated Aluminum, Polymer
Lens Material	Non-yellowing PMMA
Base Type	GU24

#### ELECTRICAL

Power Consumption	S38.09 13W/ S38.11 18W
Power Factor	>0.9
Current	170 mA Max
Efficacy	S38.09 69 lm/W / S38.11 62 lm/W

#### ACCESSORIES

S38 Accessory Snoot 30° cutoff, White	<b>S38ASNT30WH</b>	S38 Accessory Louver 45° cutoff, Black (Requires S38ASNT55)	<b>S38ALUV45BK</b>
S38 Accessory Snoot 30° cutoff, Black	<b>S38ASNT30BK</b>	S38 Accessory Baffle 15° cutoff, Black (Requires S38ASNT30)	<b>S38ABFL15BK</b>
S38 Accessory Snoot 55° cutoff, White	<b>S38ASNT55WH</b>		
S38 Accessory Snoot 55° cutoff, Black	<b>S38ASNT55BK</b>		

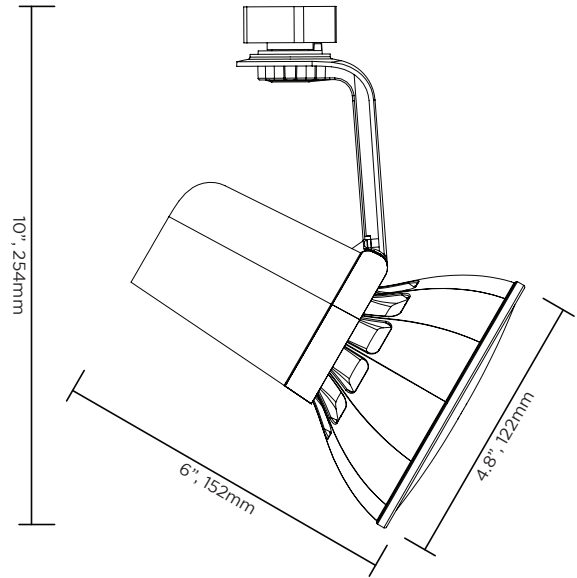

CAD files available upon request

<sup>1</sup>All performance measurements taken at 3000K, 25°C ambient, 100% power input, unless otherwise stated.

<sup>2</sup>Lumen measurement complies with IES LM-79-08 testing procedures.

<sup>3</sup>See color gamut chart at the end of this document.

<sup>4</sup>Lumen maintenance values calculated in accordance to TM-21 procedures based on LM-80 compliant measurement data.

<sup>5</sup>Intensity and color point controlled via Ketra's wireless network

<sup>6</sup>Suitable for use in fully enclosed luminaires

770-000016-01 r07

Specifications are subject to change without notice

## S30 ISO FOOTCANDLE CHARTS: 2700 - 5000K VALUES ONLY

LM-79 compliant IES files available upon request.

### BEAM ANGLE: 10° SPOT (SP)

Product Code <sup>1</sup>	Wattage	Lumens	CBCP
<b>S3811BTSP1E26WH</b>	<b>18W</b>	<b>1100</b>	<b>11,593</b>

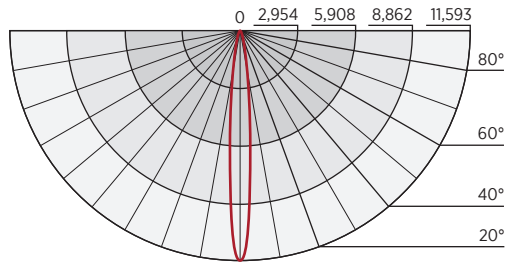
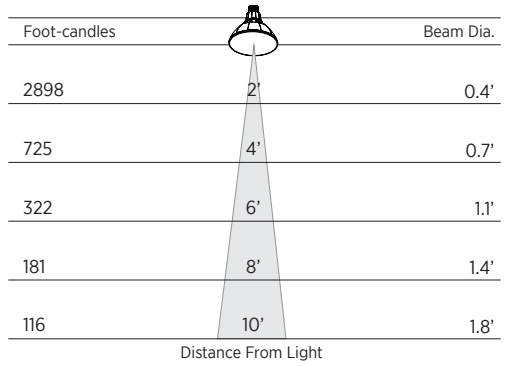

### BEAM ANGLE: 25° FLOOD (FL)

Product Code <sup>1</sup>	Wattage	Lumens	CBCP
<b>S3811BTFL1E26WH</b>	<b>18W</b>	<b>1100</b>	<b>4873</b>

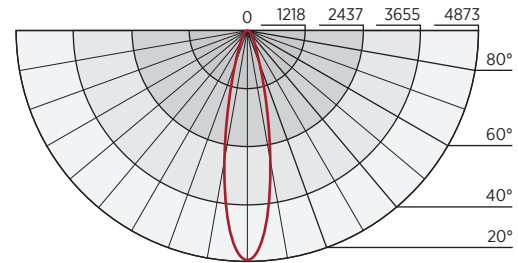
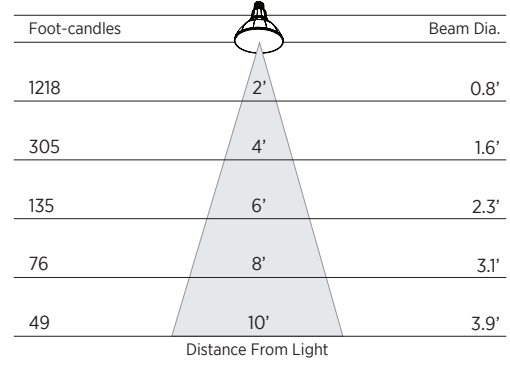

### BEAM ANGLE: 40° WIDE FLOOD (WFL)

Product Code <sup>1</sup>	Wattage	Lumens	CBCP
<b>S3811BTWFL1E26WH</b>	<b>18W</b>	<b>1100</b>	<b>1217</b>

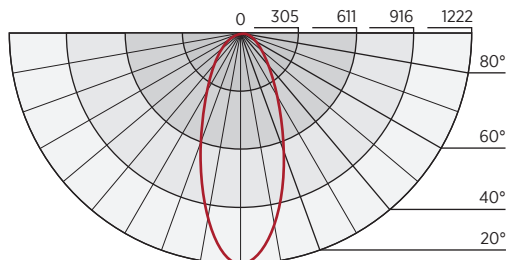
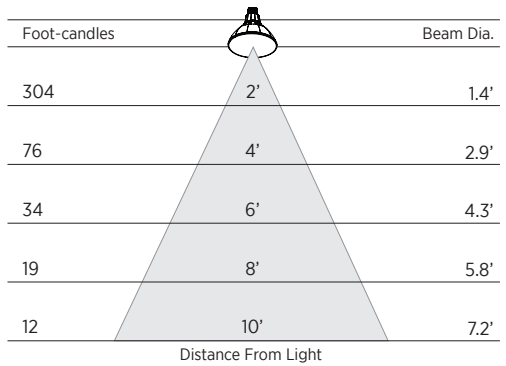

### BEAM ANGLE: 60° VERY WIDE FLOOD (VFL)

Product Code <sup>1</sup>	Wattage	Lumens	CBCP
<b>S3811BTVFL1E26WH</b>	<b>18W</b>	<b>1100</b>	<b>818</b>

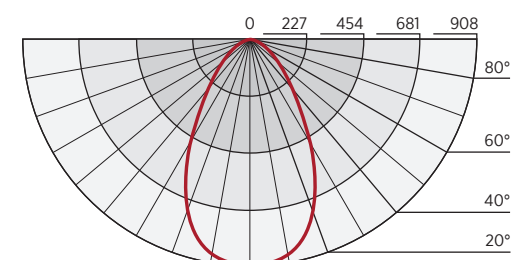
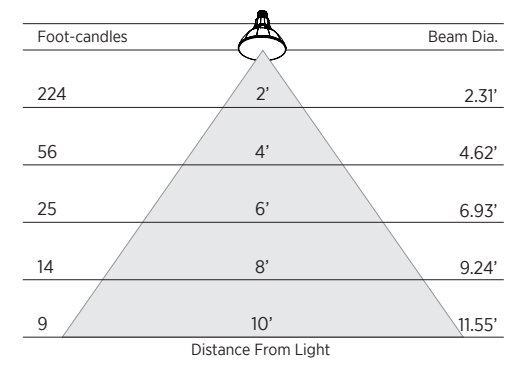

## WIDE GAMUT:

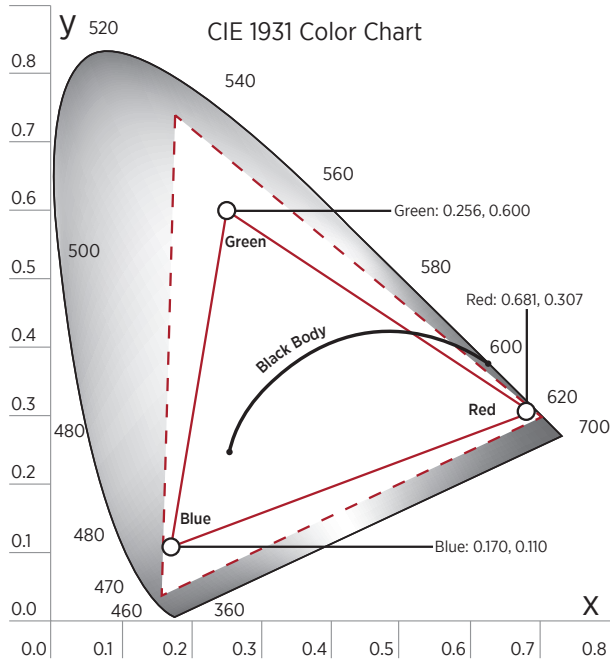

Ketra's tunable spectrum lamp can easily be configured via our intuitive Design Studio software tool. The product can reproduce any color point within the triangle shaped gamut indicated in the chart below. With Ketra's innovative optical and thermal feedback system, the color point is maintained to an accuracy of <1 MacAdam ellipse over the lifetime of the product and across operating temperature range.

- Calibrated Gamut: Color point is maintained to an accuracy of <1 MacAdam ellipse over the lifetime of the product and across operating temperature range.
- - - Expanded Gamut: Color calibration is relaxed such that each product produces the most saturated color possible.

## GENERAL SPECIFICATIONS

LED Track Luminaire shall employ closed loop optical and thermal feedback capable of maintaining color point accuracy of <1 MacAdam ellipse.

LED Track Luminaire shall have color spatial uniformity of <2 MacAdam ellipses over full field angle.

LED Track Luminaire shall have an integrated wireless control on-board.

LED PAR38 lamp shall be capable of a CRI >90 at any point along the Black Body Curve from 2700 - 5000K.

LED Track Luminaire shall be a single source multi-die emitter consisting of both monochromatic and phosphor converted blue LED dye.

LED Track Luminaire shall be sealed, meeting UL damp location and IP50 requirements.

LED Track Luminaire shall be lamped with GU24 base lamps.

LED Track Luminaire shall be dimmable to 0.1% of measured luminous flux with wireless or TRIAC dimming.

LED Track Luminaire shall be UL listed and RoHS compliant.

LED Track Luminaire shall be capable of in situ firmware and software upgrades.

Ketra LED Lamps are warranted to be free from material defects in material and workmanship for five (5) years or 25,000 hours from date of shipment, whichever is less

LED Track Luminaire shall be # \_\_\_\_\_