

# KETRA

## STATIC WHITE D3 SQUARE FIXED FLANGELESS DEEP PINHOLE

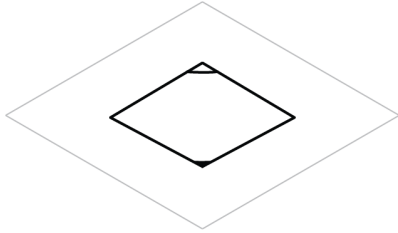

Project: \_\_\_\_\_  
 Comments: \_\_\_\_\_  
 Prepared By: \_\_\_\_\_

Single-point source produces high fidelity, 90+ CRI/R9 Whites.

Closed-loop color point maintenance to <1 MacAdam ellipse over lifetime and temperature

Integrated temperature protection maintains safe operating conditions

Wirelessly dimmable to 0.1%

On-board wireless control enables individual addressability and control

### HARDWARE ORDERING GUIDE

#### TRIM

D3TXSP2	Trim Color	Trim Accessory	Code
Series & Trim			
3.75" Square Flangeless Deep Pinhole			D3TXSP2
Trim Color			
White			WH
Black			BK
Trim Accessory <sup>1</sup> (See diagram on page 3)			
None			N
Solite Lens			S
Frost Lens <small>(None of the Trim Accessories listed above can be used with Optic Accessories)</small>			F

#### HOUSING

D3FXSM	Wattage	Platform & Color Point	Beam Angle	Voltage	NCIC	Optic Accessory	Shipping Option	Code
Fixture & Trim								
3.75" Fixed Square Flangeless Downlight								D3FXSM
Wattage								
9 Watts								09
13 Watts								13
18 Watts								18
Platform & Color Point								
2700K								B27
3000K								B30
3500K								B35
4000K								B40
Beam Angle								
Spot (15°) Low Glare								15L
Flood (25°) Low Glare								25L
Wide Flood (40°) Low Glare								40L
Very Wide Flood (60°) Low Glare								60L
Spot (15°) High Output								15H
Flood (25°) High Output								25H
Wide Flood (40°) High Output								40H
Very Wide Flood (60°) High Output								60H
Voltage								
120VAC 60Hz								11
220-277VAC 60Hz (available Q2 '17)								21
220-277VAC 50Hz (available Q2 '17)								22
Housing Type								
New Construction, IC/Airtight								NCIC
Optic Accessory (See diagram on page 3)								
None								N
Solite								S
Frost Lens								F
Hex Louver <small>(None of the Trim Accessories listed above can be used with Optic Accessories)</small>								H
Shipping Option								
Single Pack (Default, ships with Butterfly Brackets & 24" Nailer Bars to be installed in field)								SP
Bulk Pallet w/ Butterfly Brackets (available for qty's greater than 20 units, Butterfly Bracket is pre-installed)								BB
Bulk Pallet w/ 24" Nailer Bars (available for qty's greater than 20 units, 24" Nailer Bars pre-installed)								BN

<sup>1</sup> Downlight is wet location rated when trim is installed with lens.

# KETRA

STATIC WHITE D3 SQUARE FIXED FLANGELESS DEEP PINHOLE

## SPECIFICATIONS<sup>1</sup>

### OPTICAL & ELECTRICAL PERFORMANCE

#### Delivered Lumen Output<sup>2</sup>

Beam Angle (1" recess)	9W	13W	18W
15° beam low glare	650lm	882lm	1092lm
25° beam, low glare	623lm	845lm	1046lm
40° beam, low glare	569lm	772lm	955lm
60° beam, low glare	561lm	760lm	941lm
15° beam high output	682lm	928lm	1148lm
25° beam, high output	678lm	923lm	1142lm
40° beam, high output	646lm	878lm	1087lm
60° beam, high output	630lm	857lm	1061lm

CRI (Ra)	>90 (R9>90)
Lumen Maintenance <sup>4</sup>	50,000 hours to L70 @ 25°C T <sub>A</sub>
Color Spatial Uniformity	<2 MacAdam ellipses across field angle
Color Point Options	2700K, 3000K, 3500K, 4000K
Equivalent Traditional Lamp	75W halogen
Dimming Range <sup>5</sup>	0.1-100%lm
Power consumption	D3.09 9W D3.13 13W D3.18 18W
Voltage	120VAC 60Hz 220-277VAC 60Hz 220-277VAC 50Hz
Power Factor	>0.9
Current	150 mA Max

#### Delivered Efficacy

Beam Angle (1" recess)	9W	13W	18W
15° beam, low glare	72lm/W	68lm/W	6lm/W
25° beam, low glare	69lm/W	65lm/W	58lm/W
40° beam, low glare	63lm/W	59lm/W	53lm/W
60° beam, low glare	62lm/W	58lm/W	52lm/W
15° beam, high output	76lm/W	71lm/W	63lm/W
25° beam, high output	75lm/W	71lm/W	62lm/W
40° beam, high output	72lm/W	68lm/W	59lm/W
60° beam, high output	70lm/W	66lm/W	58lm/W

Surge Protection	2.5KV
Control Protocol	KetraNet Mesh

### ENVIRONMENTAL

Operating Temperature (T <sub>A</sub> )	0 - 40°C
Storage Temperature	-20 - 80°C
Humidity	0 - 95%, Non-condensing
Certification	UL, cUL, RoHS, FCC Class B
Location	UL Damp Location, UL Wet Location Available with Lens Trim

### MECHANICAL

Mounting Options	Hanger Bars/ Butterfly Brackets
Field Replaceable Optics	Yes
Field Replaceable Light Engine <sup>6</sup>	Yes
Field Replaceable Power Supply	Yes
Additional Optic Lens Holder	2.5" Lens, 1/8" Thick
Additional Trim Lens Holder	2.75" Lens, 1/8" Thick
Housing Material	Powder Coated Steel, Polymer
Lens Material	Glass

### DIMENSIONS

Ceiling Hole Diameter	5.5" Flangeless
Trim Outside Diameter	4.62"
Trim Inside Diameter	3.75"
Trim Thickness	1/16"
Optics Outside Diameter	2.5"
Trim Depth	2"
Ceiling Thickness	0.625" - 1.5"
Emitter Vertical Adjustment (tool-free)	0.75"
Housing Vertical Adjustment via Butterfly Bracket	1.75"
Housing Aperture Rotation	360°
Housing Height	3.50"
Housing Length	18.38"
Housing Width	10.07"

<sup>1</sup> All performance measurements taken with 1" trim, with light engine at nadir at the low regress position, at 3000K, 25°C ambient, 100% power input, unless otherwise stated.

<sup>2</sup> Lumen measurement complies with IES LM-79-08 testing procedures.

<sup>3</sup> Lumen maintenance values calculated in accordance to TM-21 procedures based on LM-80 compliant measurement data.

<sup>4</sup> Intensity and color point controlled via Ketra's wireless network.



770-000028-02 r1

Specifications are subject to change without notice

# KETRA

STATIC WHITE D3 SQUARE FIXED FLANGELESS DEEP PINHOLE

## COMPONENT ORDERING GUIDE

REPLACEMENT OPTICS			ACCESSORIES <sup>1</sup>			MOUNTING KITS		
D3	OP		D3			D3	MA	
Series	Accessory Type	Beam Angle	Series	Accessory		Series	Accessory Type	Mounting Accessory
Code			Code			Code		
Series			Series			Series		
3.75" Recessed Downlight		D3	3.75" Recessed Downlight		D3	3.75" Recessed Downlight		D3
Accessory Type			Accessory <sup>2</sup>			Accessory Type		
Optic		OP	See Image			Mounting Accessory		MA
Beam Angle			Square Pinhole Trim Lens Solite		TLSPS	Mounting Accessory		
Spot (15°) Low Glare		15L	Square Pinhole Trim Lens Frost		TLSPF	(2) Butterfly Brackets		B
Flood (25°) Low Glare		25L	Optic Accessory Solite		OAS	(2) 24" Nailer Bar		N
Wide Flood (40°) Low Glare		40L	Optic Accessory Frost		OAF			
Very Wide Flood (60°) Low Glare		60L	Optic Accessory Hex Louver		OAH			
Spot (15°) High Output		15H						
Flood (25°) High Output		25H						
Wide Flood (40°) High Output		40H						
Very Wide Flood (60°) High Output		60H						

<sup>1</sup> Downlight is wet location rated when trim is installed with lens.

<sup>2</sup> Only one optional optical or trim accessory can be used at a time.

## LENS ACCESSORY PLACEMENT

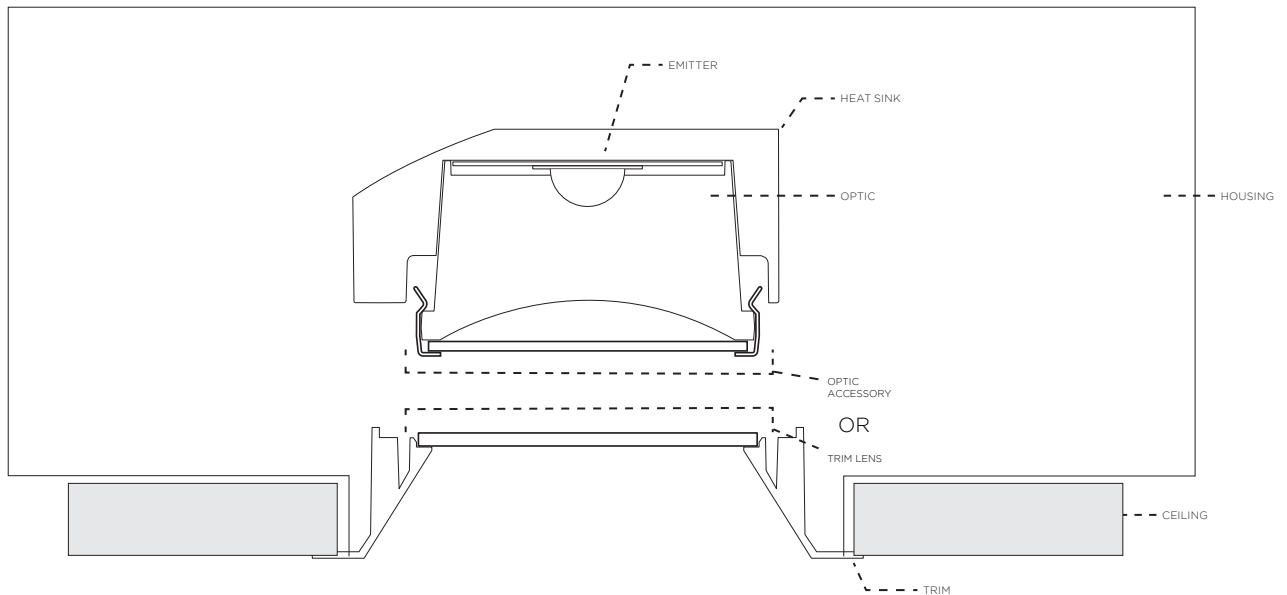

770-000028-02 r1

Specifications are subject to change without notice

# KETRA

## STATIC WHITE D3 SQUARE FIXED FLANGELESS DEEP PINHOLE

### HOUSING

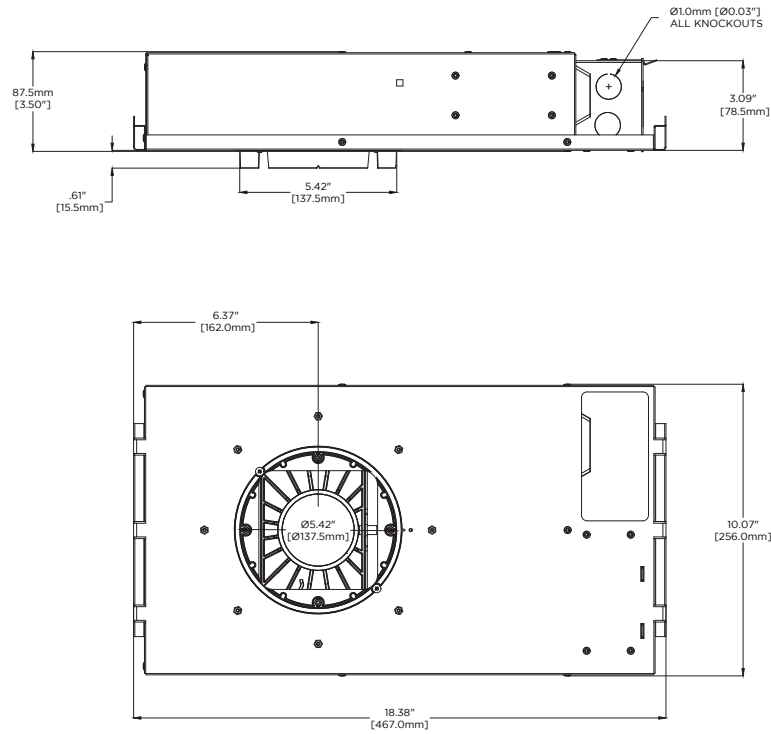

### TRIM

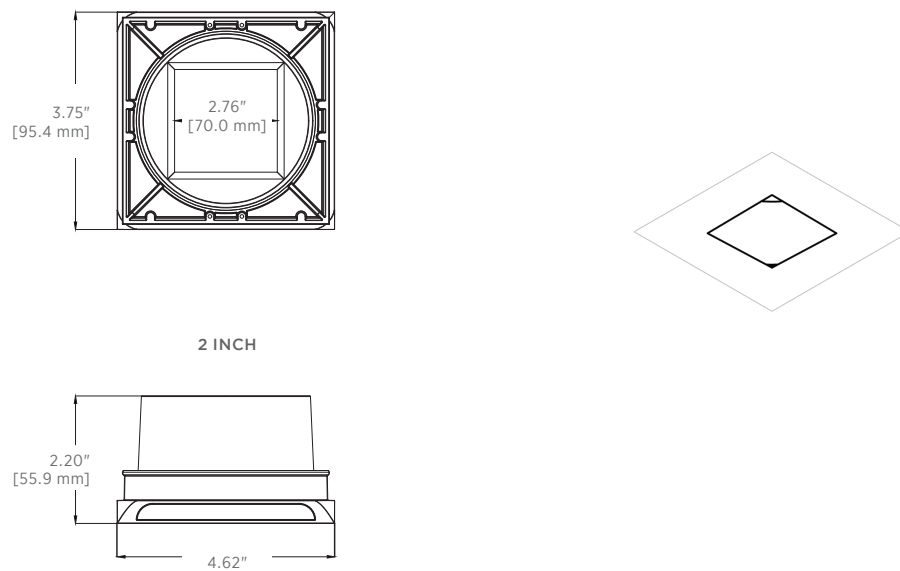

770-000028-02 r1  
Specifications are subject to change without notice

# KETRA

STATIC WHITE D3 SQUARE FIXED FLANGELESS DEEP PINHOLE

ISO FOOTCANDLE CHARTS: 2700K, 3000K, 3500K, 4000K DELIVERED LUMENS

LM-79 compliant IES files available upon request.

## BEAM ANGLE: 15° SPOT, LOW GLARE

Product Code <sup>1</sup>	Wattage	Delivered Lumens	CBCP
D3FXSM18B2715L	18W	1092	7603

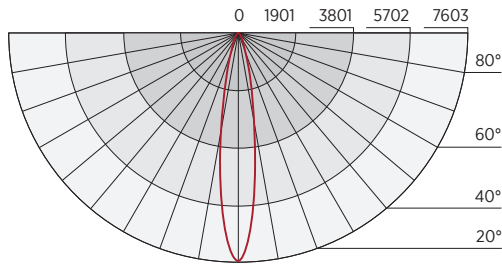
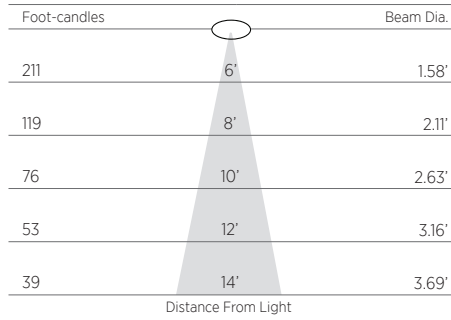

## BEAM ANGLE: 15° SPOT, HIGH OUTPUT

Product Code <sup>1</sup>	Wattage	Delivered Lumens	CBCP
D3FXSM18B2715H	18W	1148	9279

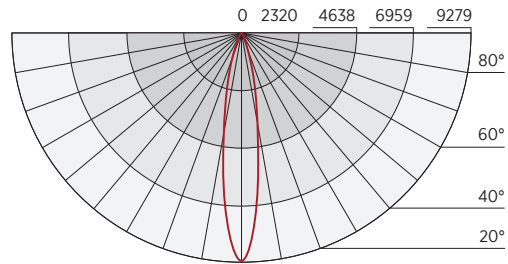
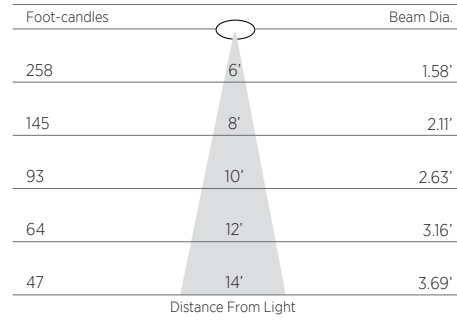

## BEAM ANGLE: 25° SPOT, LOW GLARE

Product Code <sup>1</sup>	Wattage	Delivered Lumens	CBCP
D3FXSM18B2725L	18W	1046	4198

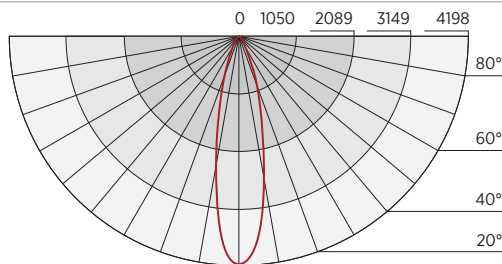
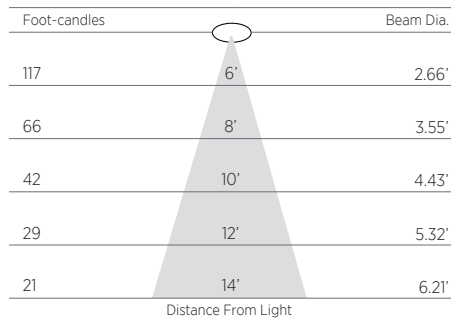

## BEAM ANGLE: 25° SPOT, HIGH OUTPUT

Product Code <sup>1</sup>	Wattage	Delivered Lumens	CBCP
D3FXSM18B2725H	18W	1142	4297

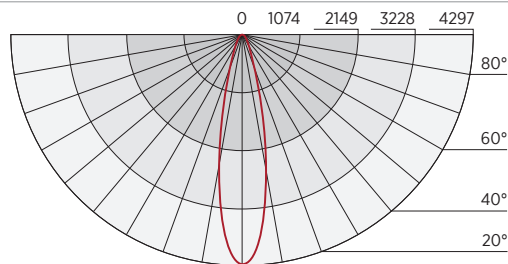
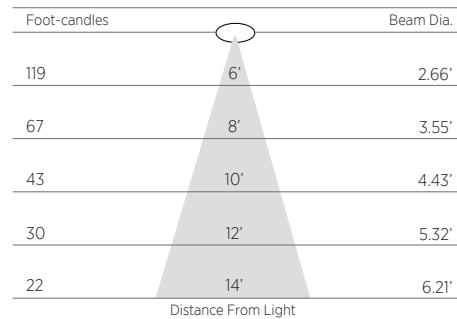

<sup>1</sup> Performance data applies to all base types and housing colors.

# KETRA

STATIC WHITE D3 SQUARE FIXED FLANGELESS DEEP PINHOLE

ISO FOOTCANDLE CHARTS: 2700K, 3000K, 3500K, 4000K DELIVERED LUMENS

LM-79 compliant IES files available upon request.

## BEAM ANGLE: 40° WIDE FLOOD, LOW GLARE

Product Code <sup>1</sup>	Wattage	Delivered Lumens	CBCP
D3FXSM18B2740L	18W	955	2041

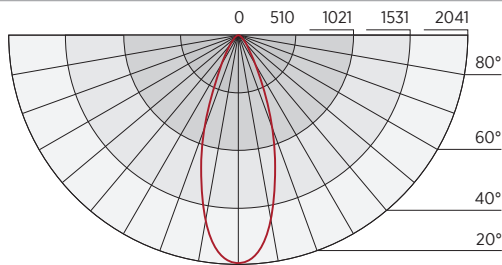
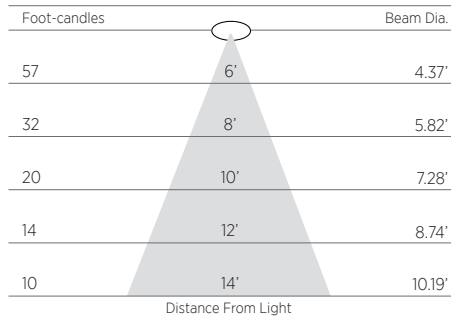

## BEAM ANGLE: 40° WIDE FLOOD, HIGH OUTPUT

Product Code <sup>1</sup>	Wattage	Delivered Lumens	CBCP
D3FXSM18B2740H	18W	1087	2170

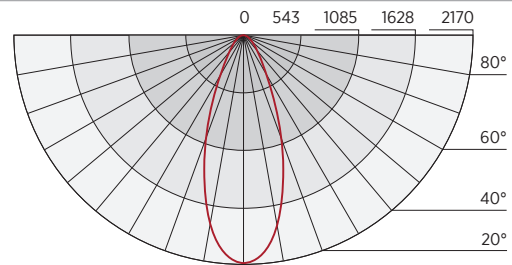
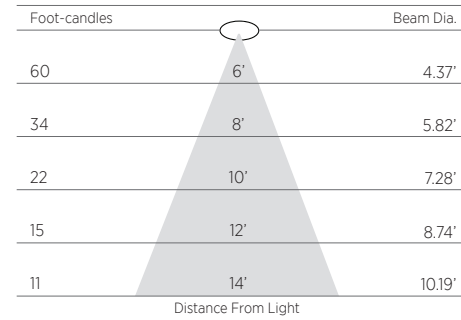

## BEAM ANGLE: 60° VERY WIDE FLOOD, LOW GLARE

Product Code <sup>1</sup>	Wattage	Delivered Lumens	CBCP
D3FXSM18B2760L	18W	941	1235

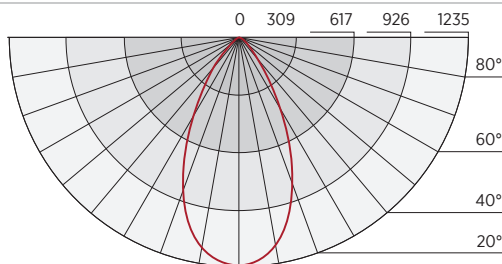
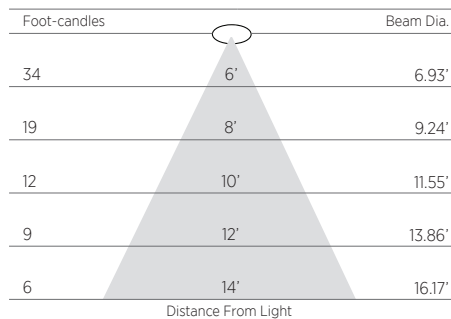

## BEAM ANGLE: 60° VERY WIDE FLOOD, HIGH OUTPUT

Product Code <sup>1</sup>	Wattage	Lumens	CBCP
D3FXSM18B2760H	18W	1061	1257

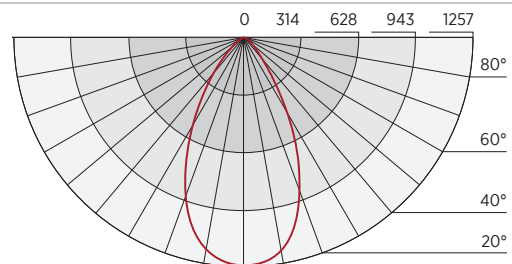
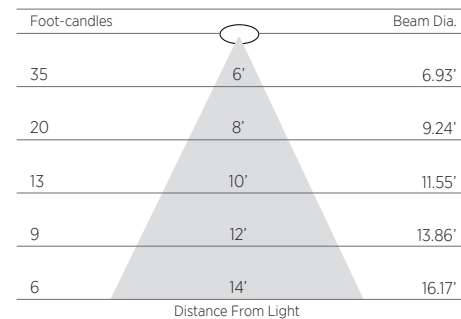

<sup>1</sup> Performance data applies to all base types and housing colors.

# K E T R A

STATIC WHITE D3 SQUARE FIXED FLANGELESS DEEP PINHOLE

---

## GENERAL SPECIFICATIONS

LED downlight shall employ closed loop optical and thermal feedback capable of maintaining color point accuracy of <1 MacAdam ellipse.

LED downlight shall have color spatial uniformity of <2 MacAdam ellipses over full field angle.

LED downlight shall have an integrated wireless control onboard.

LED downlight shall be capable of a CRI >90 along the Black Body Curve at 2700K, 300K, 3500K, or 4000K.

LED downlight lamp shall be a single source multi-die emitter consisting of both monochromatic and phosphor converted blue LED dye.

LED downlight shall be sealed, meeting UL damp location (and UL Wet Location with Wet Location Trim) requirements.

LED downlight shall be dimmable to 0.1% of measured luminous flux with wireless dimming.

LED downlight shall be UL listed and RoHS compliant.

LED downlight shall be capable of in situ firmware and software upgrades.

Ketra LED Fixtures are warranted to be free from material defects in material and workmanship for five (5) years or 25,000 hours from date of shipment, whichever is less.

LED D3 Fixture shall be # \_\_\_\_\_

770-000028-02 r1

Specifications are subject to change without notice